

**Unit: 3<sup>rd</sup> – Perimeter, Area & Geometry****Lesson: 3.7.B – Perimeter****Problem Set: 1**

*Note: Some parts of these materials are taken directly from released STAAR tests Copyright © 2015-2021. Texas Education Agency. All Rights Reserved. Used by Permission.*

<b>1.</b>  C	<b>2.</b>  A	<b>3.</b>  B	<b>4.</b>  B	<b>5.</b>  196	<b>6.</b>  B (5 cm X 4 cm)
<b>7.</b>  A	<b>8.</b>  D (5 cm X 8 cm)	<b>9.</b>  D	<b>10.</b>  13 feet	<b>11.</b>  96 cm	<b>12.</b>  B
<b>13.</b>  D	<b>14.</b>  C	<b>15.</b>  C	<b>16.</b>  120 inches	<b>17.</b>  D (11 cm X 9 cm)	<b>18.</b>  A
<b>19.</b>  B (7 cm X 9 cm)	<b>20.</b>  C	<b>21.</b>  16 feet	<b>22.</b>  128	<b>23.</b>  A	<b>24.</b>  C
<b>25.</b>  C	<b>26.</b>  208 inches	<b>27.</b>  B	<b>28.</b>  B (4 cm X 7 cm)	<b>29.</b>  A	<b>30.</b>  18 inches



1. The lengths of four sides of a polygon are shown in the diagram.

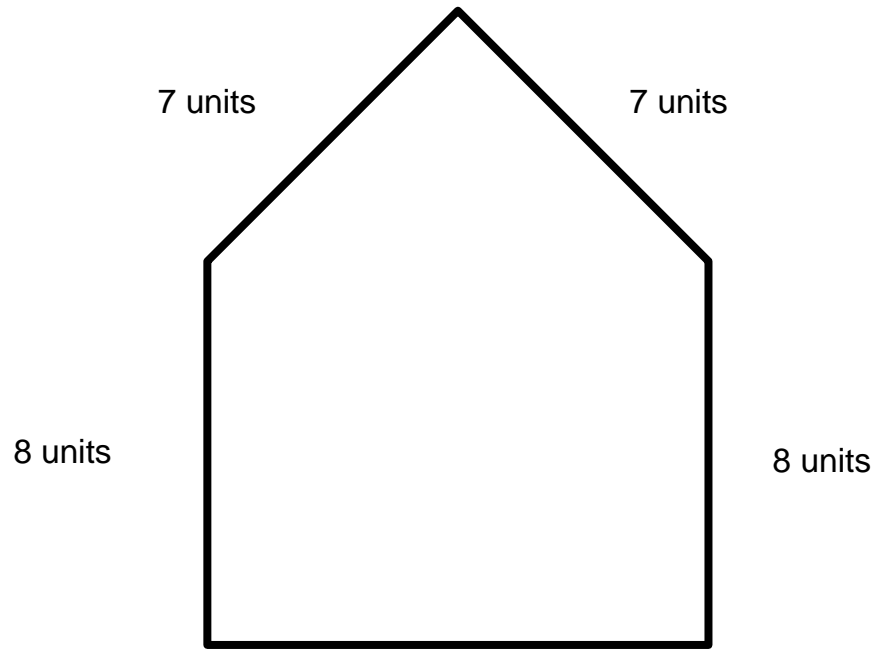

The perimeter of the polygon is 40 units. What is the missing length in units?

- A. 8 units
- B. 15 units
- C. 10 units
- D. 30 units

2. Felix drew the figures shown below.

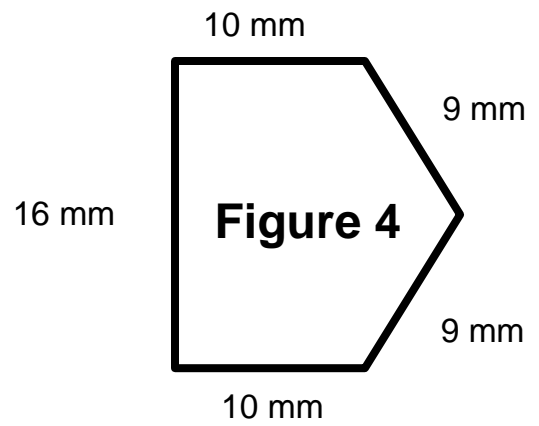
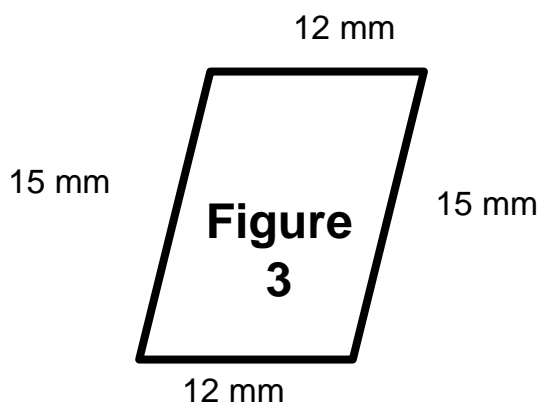
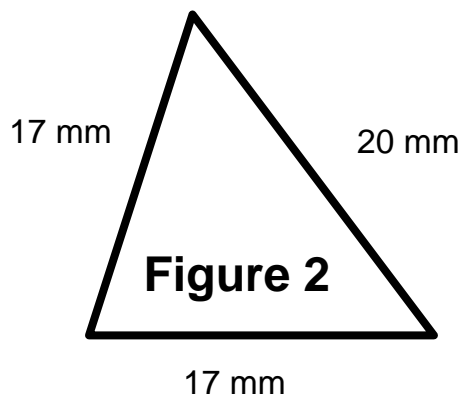
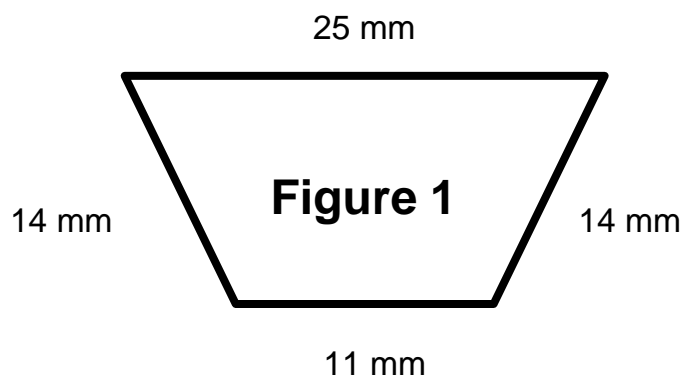

Which list shows all the figures that have a perimeter of 54 millimeters?

- A. Figures 2, 3, and 4
- B. Figures 2 and 4
- C. Figures 1 and 3
- D. Figures 1,2,4

3. A triangle has a perimeter of 18 units. Each side of this triangle is the same length.

What is the length of one side of the triangle in units?

- A. 3 units
- B. 6 units
- C. 19 units
- D. 54 units

4. A triangular sign has a perimeter of 44 centimeters. Two of the sides are each 14 centimeters long. What is the length of the third side in centimeters?

A. 28 cm

B. 16 cm

C. 30 cm

D. 14 cm

5. Holly made a poster using two congruent pentagons and a square.

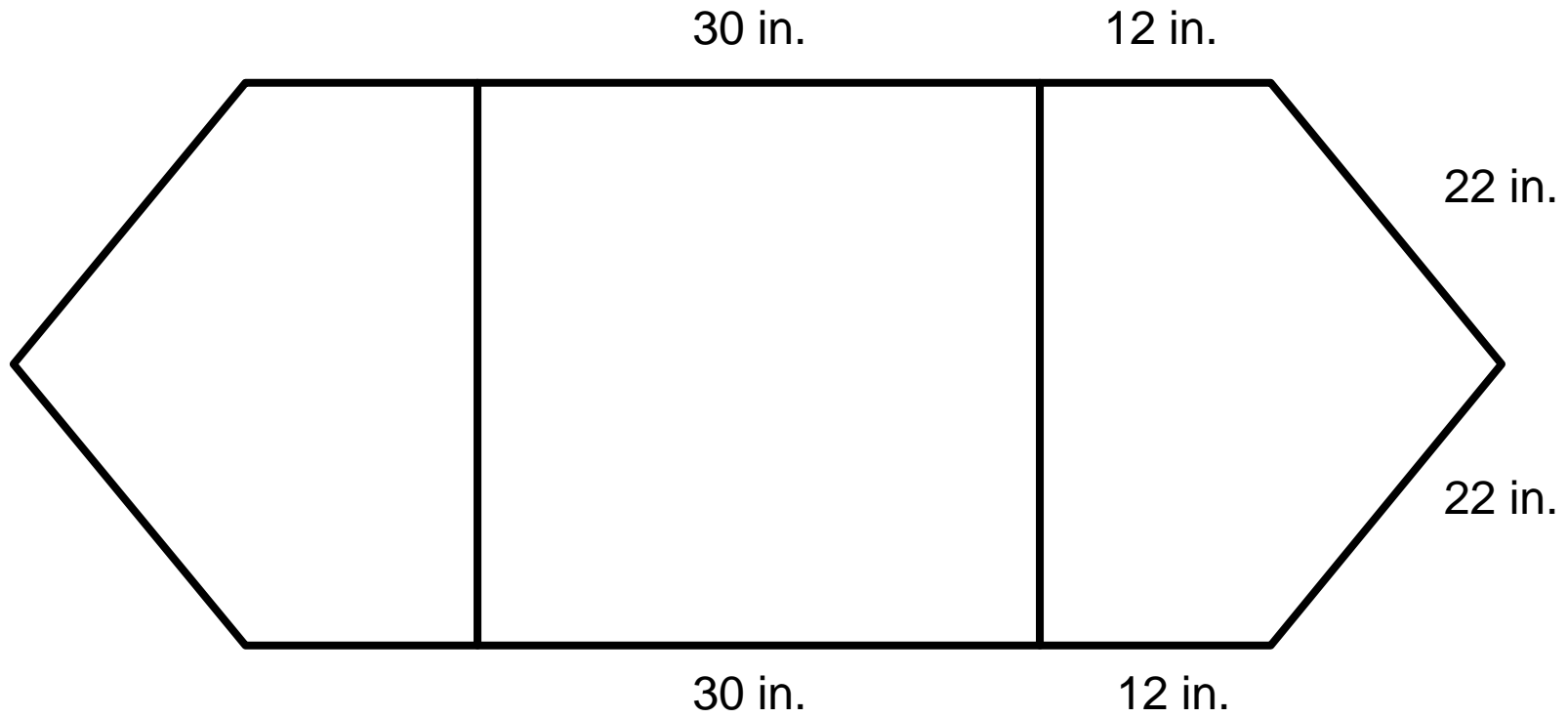

What is the perimeter of the poster in inches?

6. A rectangular business card is shown. Use the ruler provided to measure the length and width of the business card to the nearest centimeter.



Which measurement is closest to the perimeter of the business card in centimeters?

- A. 14 cm
- B. 18 cm
- C. 45 cm
- D. 32 cm



**3.7.B – Perimeter  
Problem Set: 2**

<b>1.</b>  C	<b>2.</b>  A	<b>3.</b>  B	<b>4.</b>  B	<b>5.</b>  196	<b>6.</b>  B (5 cm X 4 cm)
<b>7.</b>  A	<b>8.</b>  D (5 cm X 8 cm)	<b>9.</b>  D	<b>10.</b>  13 feet	<b>11.</b>  96 cm	<b>12.</b>  B
<b>13.</b>  D	<b>14.</b>  C	<b>15.</b>  C	<b>16.</b>  120 inches	<b>17.</b>  D (11 cm X 9 cm)	<b>18.</b>  A
<b>19.</b>  B (7 cm X 9 cm)	<b>20.</b>  C	<b>21.</b>  16 feet	<b>22.</b>  128	<b>23.</b>  A	<b>24.</b>  C
<b>25.</b>  C	<b>26.</b>  208 inches	<b>27.</b>  B	<b>28.</b>  B (4 cm X 7 cm)	<b>29.</b>  A	<b>30.</b>  18 inches



7. Gretchen made this table to show the side lengths and perimeters of three figures.

Figure	Side Lengths (yards)	Perimeter (yards)
Square	6, 6, 6, 6	24
Triangle	4, 7, 8	19
Rectangle	4, 8, 4, 8	32

What mistake, if any, did Gretchen make?

- A. The perimeter of the rectangle should be 24 yards.
- B. The perimeter of the square should be 36 yards.
- C. The perimeter of the triangle should be 20 yards.
- D. Gretchen did not make any mistakes in the table.

8. A model of Mr. Estrada's rectangular calculator is shown. Use the ruler provided to measure the length and width of the calculator to the nearest centimeter.

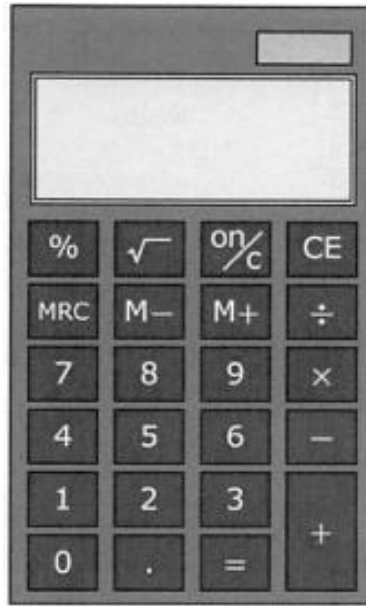

Which measurement is closest to the perimeter of the calculator in centimeters?

- A. 10 cm
- B. 32 cm
- C. 16 cm
- D. 26 cm

9. The side lengths of a rectangular mirror are shown in inches.

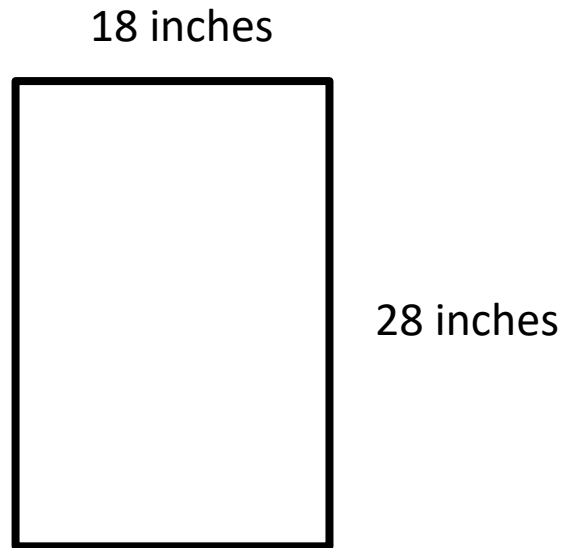

What is the perimeter of the mirror in inches?

- A. 72 in.
- B. 46 in.
- C. 74 in.
- D. 92 in.

10. The perimeter of the rectangular floor of Mr. Bryan's cabin is 46 feet. The width of the floor is 10 feet as shown.

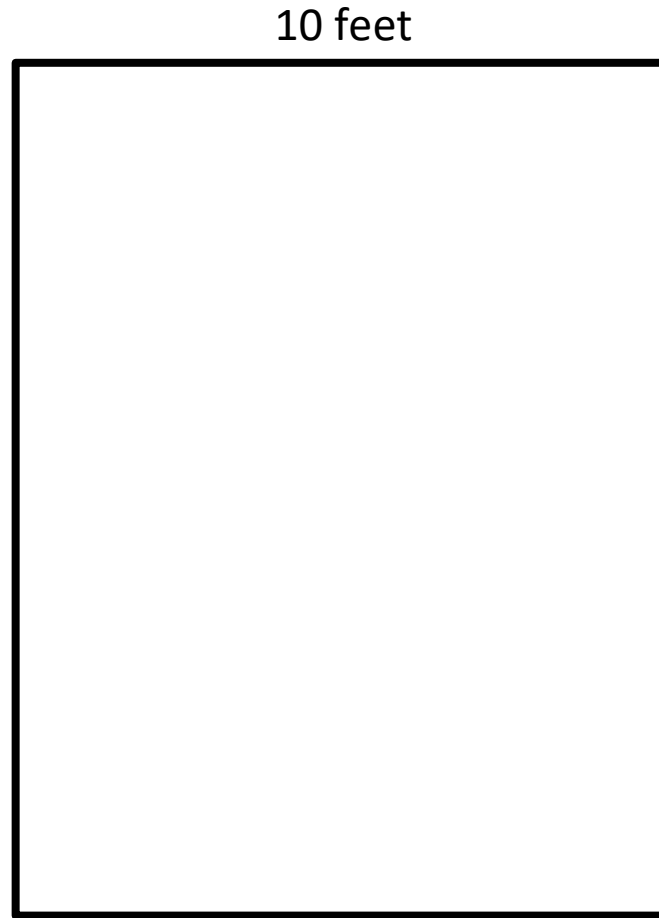

What is the length of the floor of Mr. Bryan's cabin in feet?

11. Gina's journal has a square cover with the side length shown.

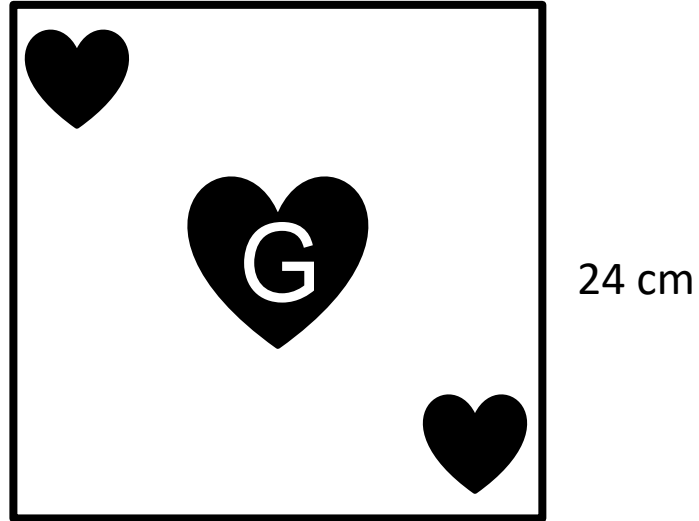

What is the perimeter of the cover of Gina's journal in centimeters?

12. The lengths of four sides of a polygon are shown in the diagram.

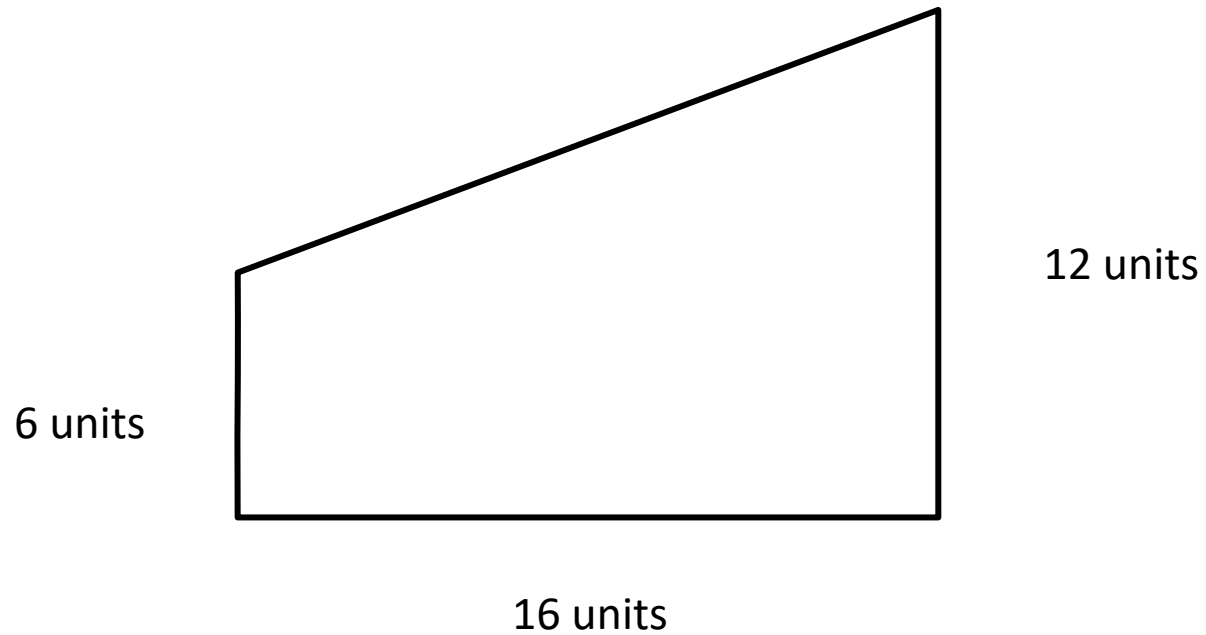

The perimeter of the polygon is 52 units. What is the missing length in units?

- A. 16 units
- B. 18 units
- C. 34 units
- D. 12 units



**3.7.B – Perimeter  
Problem Set: 3**

<b>1.</b>  C	<b>2.</b>  A	<b>3.</b>  B	<b>4.</b>  B	<b>5.</b>  196	<b>6.</b>  B (5 cm X 4 cm)
<b>7.</b>  A	<b>8.</b>  D (5 cm X 8 cm)	<b>9.</b>  D	<b>10.</b>  13 feet	<b>11.</b>  96 cm	<b>12.</b>  B
<b>13.</b>  D	<b>14.</b>  C	<b>15.</b>  C	<b>16.</b>  120 inches	<b>17.</b>  D (11 cm X 9 cm)	<b>18.</b>  A
<b>19.</b>  B (7 cm X 9 cm)	<b>20.</b>  C	<b>21.</b>  16 feet	<b>22.</b>  128	<b>23.</b>  A	<b>24.</b>  C
<b>25.</b>  C	<b>26.</b>  208 inches	<b>27.</b>  B	<b>28.</b>  B (4 cm X 7 cm)	<b>29.</b>  A	<b>30.</b>  18 inches



13. Felicia drew the figures shown below.

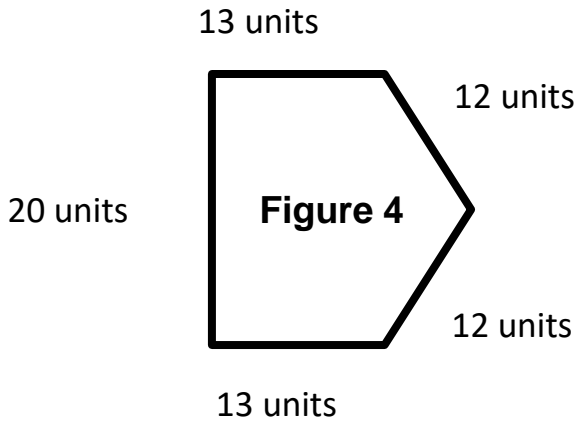
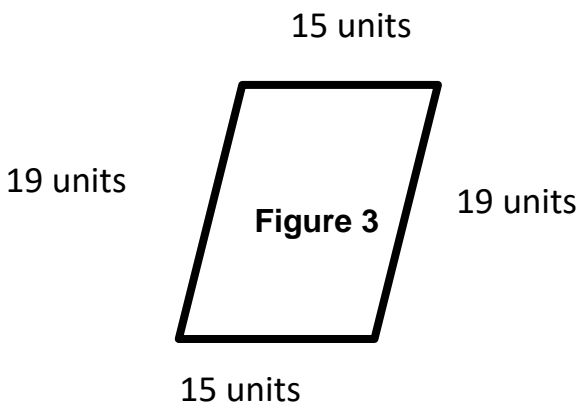
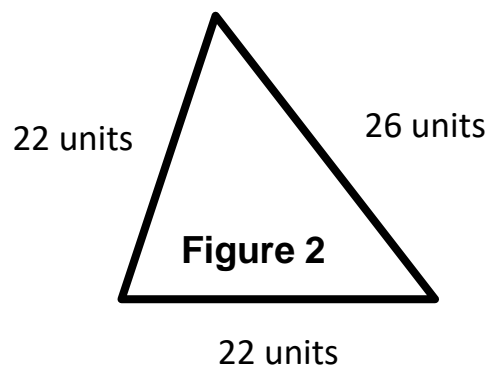
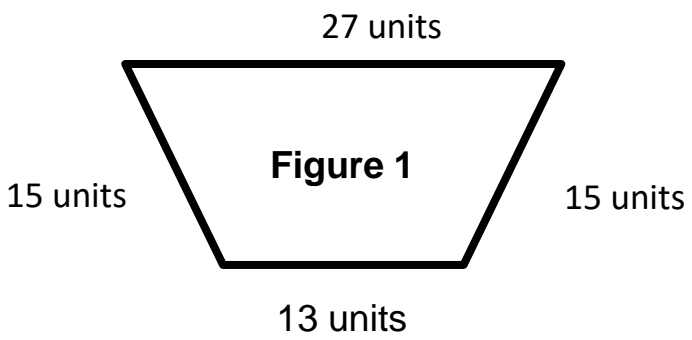

Which list shows all the figures that have a perimeter of 70 units?

- A. Figures 2, 3, and 4
- B. Figures 2 and 4
- C. Figures 1 and 3
- D. Figures 1, 2, 4

14. A triangle has a perimeter of 27 units. Each side of this triangle is the same length.

What is the length of one side of the triangle in units?

A. 3 units

B. 6 units

C. 9 units

D. 81 units

15. A triangular sign has a perimeter of 56 centimeters. Two of the sides are each 24 centimeters long. What is the length of the third side in centimeters?

A. 24 cm

B. 12 cm

C. 8 cm

D. 72 cm

16. Hannah cut this piece of wood which is a rectangle with two congruent right triangles on the ends. What is the perimeter of this piece of wood in inches?



17. A rectangular picture of a fox is shown. Use the ruler provided to measure the length and width of picture to the nearest centimeter.

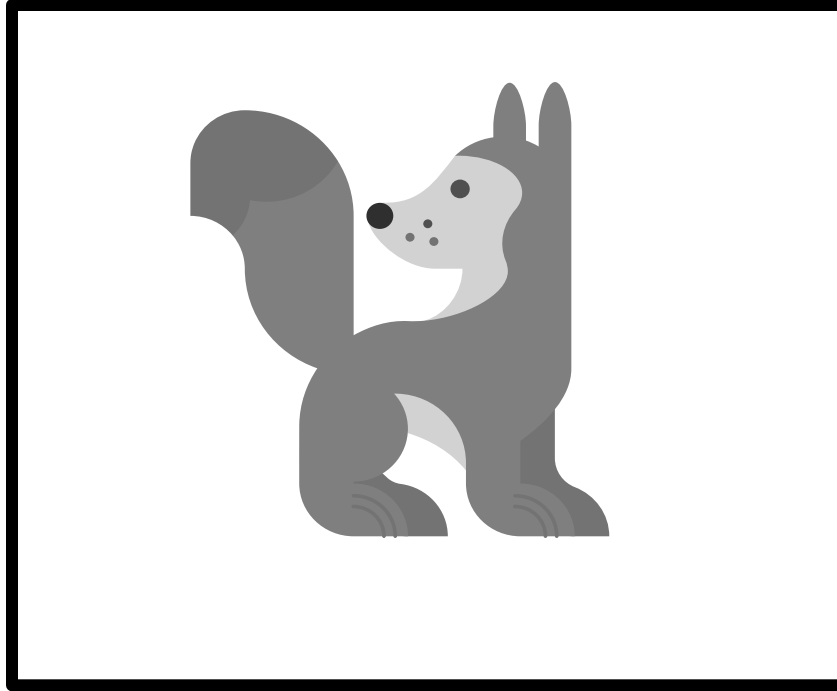

Which measurement is closest to the perimeter of the picture in centimeters?

- A. 22 cm
- B. 44 cm
- C. 48 cm
- D. 40 cm

18. Gabby made this table to show the side lengths and perimeters of three figures.

Figure	Side Lengths (yards)	Perimeter (yards)
Pentagon	4,4,4,4,4	20
Triangle	4, 7, 8	19
Rectangle	6, 10, 6, 10	36

What mistake, if any, did Gabby make?

- A. The perimeter of the rectangle should be 32 yards.
- B. The perimeter of the Pentagon should be 16 yards.
- C. The perimeter of the triangle should be 36yards.
- D. Gabby did not make any mistakes in the table.



3.7.B – Perimeter Problem Set: 4					
1.  C	2.  A	3.  B	4.  B	5.  196	6.  B (5 cm X 4 cm)
7.  A	8.  D (5 cm X 8 cm)	9.  D	10.  13 feet	11.  96 cm	12.  B
13.  D	14.  C	15.  C	16.  120 inches	17.  D (11 cm X 9 cm)	18.  A
19.  B (7 cm X 9 cm)	20.  C	21.  16 feet	22.  128	23.  A	24.  C
25.  C	26.  208 inches	27.  B	28.  B (4 cm X 7 cm)	29.  A	30.  18 inches



19. The picture from the front of a small box of cereal is shown. Use the ruler provided to measure the length and width of the picture to the nearest centimeter.



Which measurement is closest to the perimeter of the picture in centimeters?

- A. 10 cm
- B. 32 cm
- C. 16 cm
- D. 36 cm

20. The side lengths of a hallway are shown in feet.

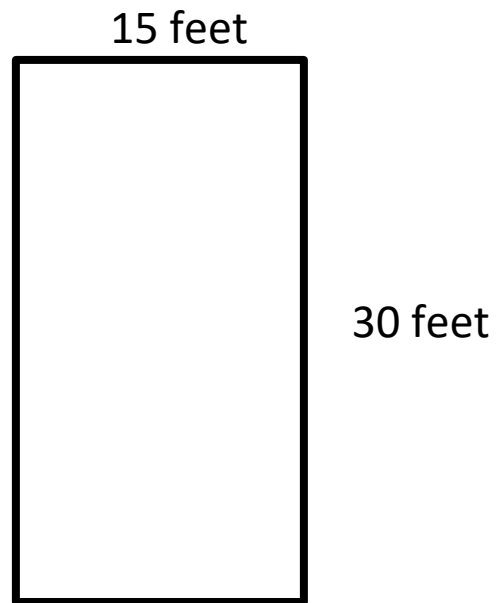

What is the perimeter of the hallway in feet?

- A. 45 feet
- B. 60 feet
- C. 90 feet
- D. 450 feet

21. The perimeter of the rectangular floor of Ms. Garrity's kitchen is 72 feet. The length of the floor is 20 feet as shown.

20 feet



What is the width of the floor in feet?

22. Lorenzo's kitchen table has a square top. One side of the tabletop is 32 inches



32  
inches

What is the perimeter of the tabletop in inches?

23. The lengths of four sides of a polygon are shown in the diagram.

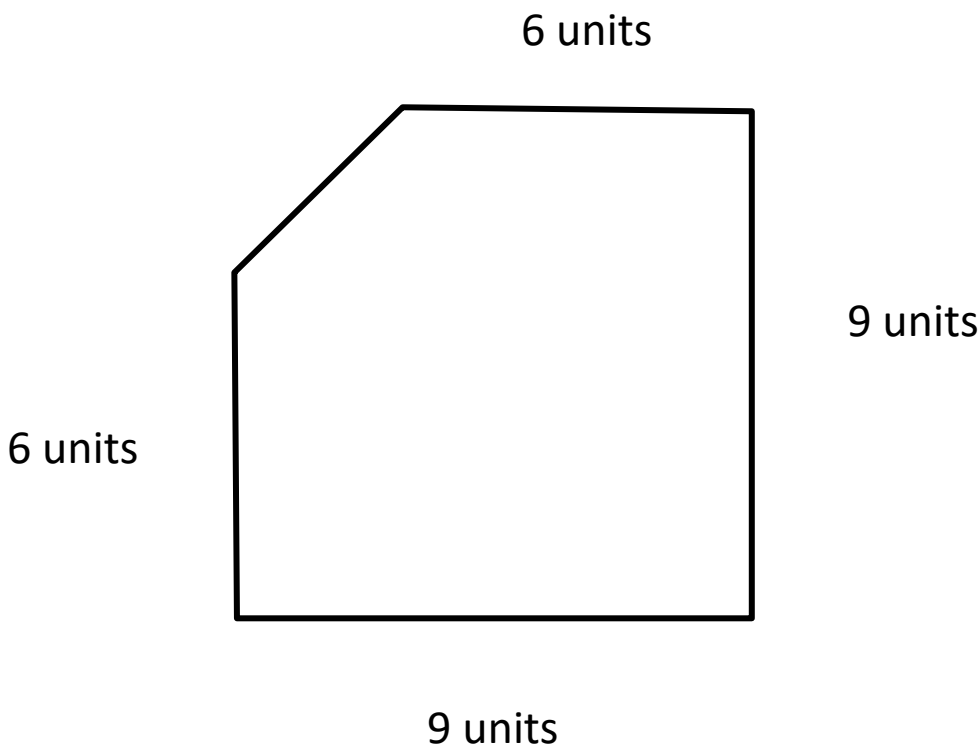

The perimeter of the polygon is 34 units. What is the missing length in units?

- A. 4 units
- B. 8 units
- C. 6 units
- D. 30 units

24. Frederica drew the figures shown below.

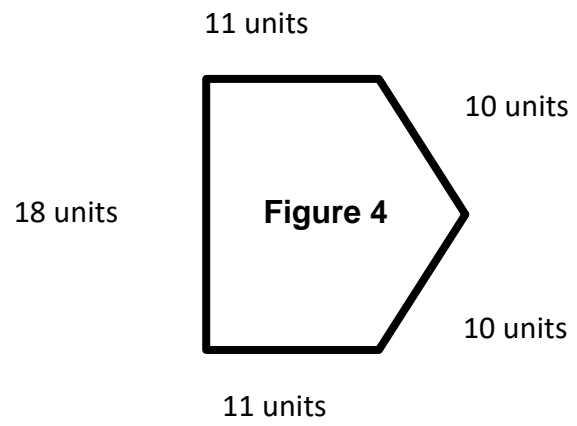
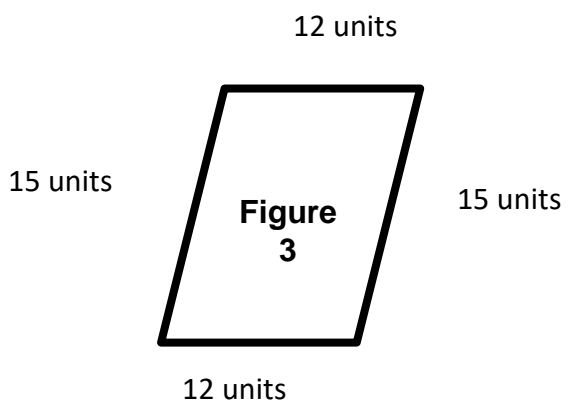
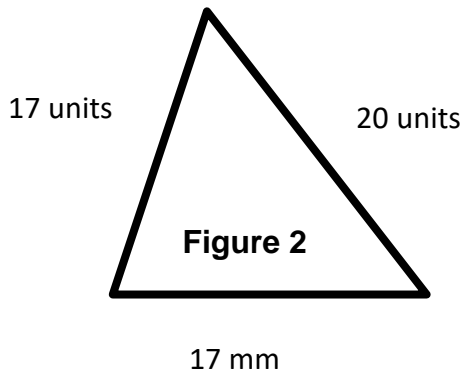
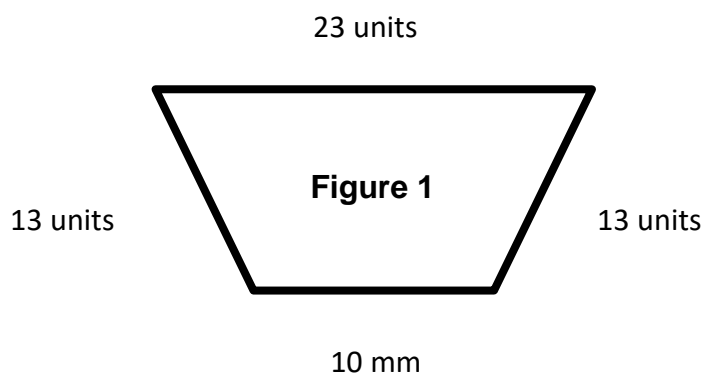

Which list shows all the figures that have a perimeter of 54 units?

- A. Figures 2, 3, and 4
- B. Figures 2 and 4
- C. Figures 2 and 3
- D. Figures 1, 2, 4



**3.7.B – Perimeter**  
**Problem Set: 5**

<b>1.</b>  C	<b>2.</b>  A	<b>3.</b>  B	<b>4.</b>  B	<b>5.</b>  196	<b>6.</b>  B (5 cm X 4 cm)
<b>7.</b>  A	<b>8.</b>  D (5 cm X 8 cm)	<b>9.</b>  D	<b>10.</b>  13 feet	<b>11.</b>  96 cm	<b>12.</b>  B
<b>13.</b>  D	<b>14.</b>  C	<b>15.</b>  C	<b>16.</b>  120 inches	<b>17.</b>  D (11 cm X 9 cm)	<b>18.</b>  A
<b>19.</b>  B (7 cm X 9 cm)	<b>20.</b>  C	<b>21.</b>  16 feet	<b>22.</b>  128	<b>23.</b>  A	<b>24.</b>  C
<b>25.</b>  C	<b>26.</b>  208 inches	<b>27.</b>  B	<b>28.</b>  B (4 cm X 7 cm)	<b>29.</b>  A	<b>30.</b>  18 inches



25. A square piece of plywood has a perimeter of 36 inches. What is the length of each side?

A. 18 inches

B. 12 inches

C. 9 inches

D. 4 inches

26. Henry made this sign using a rectangle and two congruent trapezoids.

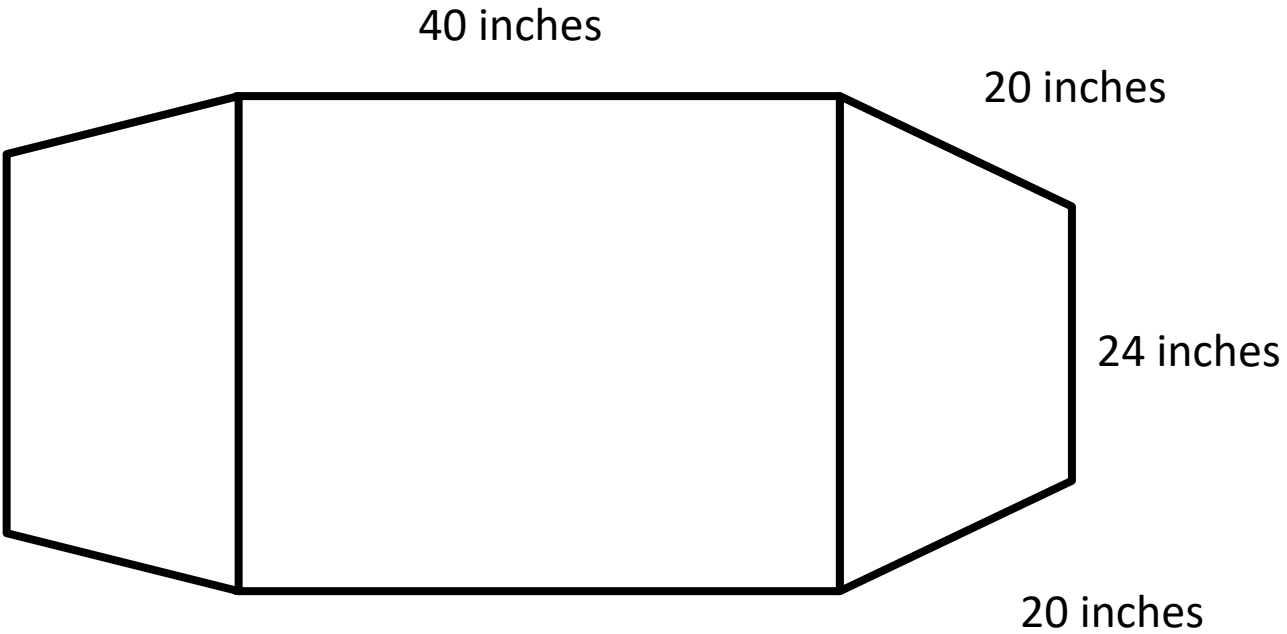

What is the perimeter of the sign in inches?

27. Augie made this table to show the side lengths and perimeters of three figures.

<b>Figure</b>	<b>Side Lengths (yards)</b>	<b>Perimeter (yards)</b>
Square	6, 6, 6, 6	36
Triangle	4, 7, 8	19
Trapezoid	10, 5, 16, 5	36

What mistake, if any, did Augie make?

- A. The perimeter of the Trapezoid should be 26 yards.
- B. The perimeter of the square should be 24 yards.
- C. The perimeter of the triangle should be 20 yards.
- D. Augie did not make any mistakes in the table.

28. A model of Monica's phone is shown. Use the ruler provided to measure the length and width of the phone to the nearest centimeter.

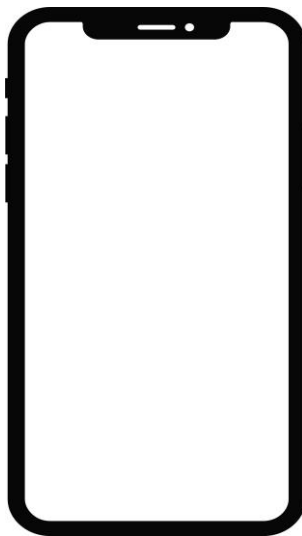

Which measurement is closest to the perimeter of the phone in centimeters?

- A. 10 cm
- B. 22 cm
- C. 28 cm
- D. 36 cm

29. The side lengths of a rectangular picture frame are shown in inches.

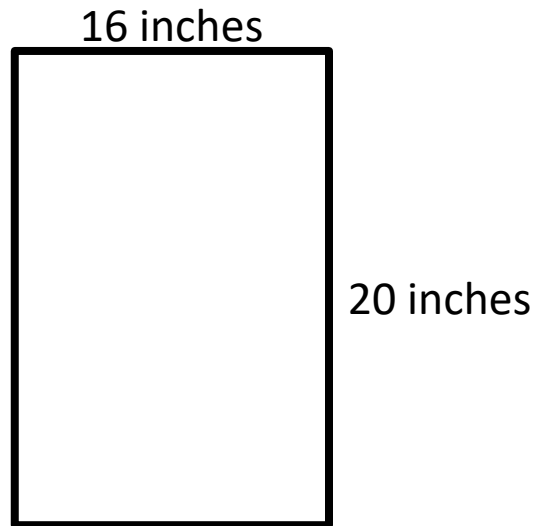

What is the perimeter of the picture frame in inches?

- A. 72 in.
- B. 46 in.
- C. 74 in.
- D. 92 in.

30. The perimeter of the box Josie plans to use for her books is 64 inches . The width of the box is 14 inches as shown.



14 Inches

What is the length Josie's box in inches?